

Safety Label Brochure for Dock Levelers

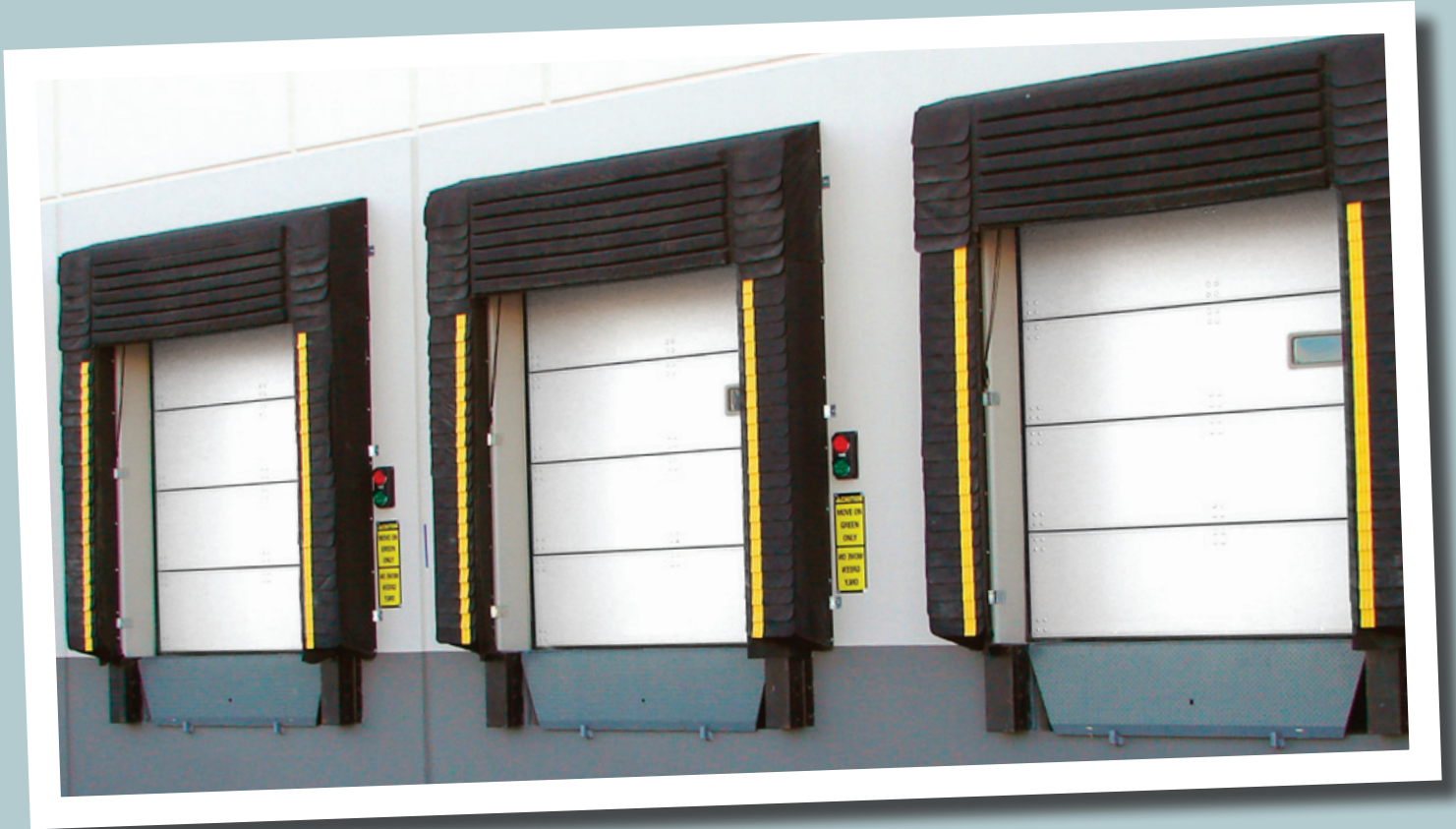

LODEM

LOADING DOCK EQUIPMENT MANUFACTURERS

A Product Section of Material Handling Industry of America

FOREWORD

This safety label brochure has been prepared by the Loading Dock Equipment Manufacturers Product Section (hereafter referred to as “LODEM”) of the Material Handling Industry of America. It has been created as a service to owners, users, designers and specifiers of loading dock levelers. The purpose of this publication is to provide voluntary guidelines for the selection and application of safety labels for use on loading dock levelers. This is a voluntary guide and should be incorporated into a comprehensive safety program by owners of loading dock levelers.

Voluntary

The use of this brochure is completely voluntary. Its existence does not in any respect preclude anyone, whether it has approved the brochure or not, from following procedures and assuming responsibilities not conforming to this brochure.

Contents

Foreword	2	Safety Signal Words	5
Introduction.....	3	Safety Label Placement Guidelines.....	6
Application Instructions.....	4		

For Questions Contact:

**Loading Dock Equipment Manufacturers Product Section of
The Material Handling Industry of America**
8720 Red Oak Boulevard, Suite 201
Charlotte, NC 28217-3992
Telephone: (704) 676-1190
FAX: (704) 676-1199
www.mhia.org

Disclaimer

DISCLAIMER OF LIABILITY: LODEM, the Material Handling Industry, MHIA, and their members assume no responsibility and disclaim all liability of any kind, however arising, as a result of acceptance or use or alleged use of this brochure. Anyone using this brochure specifically understands and agrees that LODEM, the Material Handling Industry, MHIA, their members, their officers, agents, and employees shall not be liable under any legal theory of any kind for any action or failure to act with respect to the proper selection, placement, application or use of safety labels or any other activity covered by this brochure. **DISCLAIMER OF WARRANTY:** LODEM, the Material Handling Industry, MHIA, and their members make NO WARRANTIES of any kind, express or implied, in connection with the information in this brochure and SPECIFICALLY DISCLAIM ALL IMPLIED WARRANTIES OF MERCHANTABILITY AND OF FITNESS FOR PARTICULAR PURPOSE. **INDEMNIFICATION:** By referring to or otherwise employing this brochure, its user agrees to defend, protect, indemnify, and hold LODEM, the Material Handling Industry, MHIA, their members, their officers, agents, and employees harmless from and against all claims, losses, expenses, damages, and liabilities, direct, incidental, or consequential, arising from acceptance or use or alleged use of this brochure, including loss of profits and reasonable attorneys' fees which may arise out of the acceptance or use or alleged use of this brochure. The intent of this provision and of this brochure's user is to absolve and protect LODEM, the Material Handling Industry, MHIA, their members, their officers, agents, and employees from any and all loss relating in any way to this Guide, including those resulting from the brochure user's own negligence.

Safety is a prime consideration in the design, manufacture, installation, use and maintenance of loading dock levelers. It is well-recognized that in many instances, safety labels can increase operator and maintenance personnel awareness of hazards that may be involved in loading dock levelers. Installation, operation and maintenance of dock levelers should be performed by trained personnel only.

The purpose of this publication is to provide voluntary guidelines for the selection and application of safety labels. As part of the owner's comprehensive safety program, dock levelers should be periodically inspected and safety labels reviewed to ensure their integrity and to maximize their effectiveness in avoiding accidents.

Relation to America National Standards

This brochure refers to the following ANSI standards:

ANSI Z535.1: Safety color code

ANSI Z535.2: Environmental and facility safety signs

ANSI Z535.3: Criteria for safety symbols

ANSI Z535.4: Product safety signs and labels

ANSI Z535.5: Accident prevention tags

ANSI MH30.1: Safety performance and testing of dock leveling devices

For copies of ANSI Z535 Series of Standards:

National Electrical Manufacturers Association

1300 North 17th Street
Rosslyn, Virginia 22209
Telephone: (703) 841-3200
FAX: (703) 841-5900
www.nema.org/stds/

For copies of ANSI MH30 Series of Standards:

**Loading Dock Equipment Manufacturers
Product Section of
The Material Handling Industry of America**
8720 Red Oak Boulevard, Suite 201
Charlotte, NC 28217-3992
Telephone: (704) 676-1190
FAX: (704) 676-1199
www.mhiastore.org or
www.mhia.org

APPLICATION INSTRUCTIONS

Proper procedures should be used in applying labels to equipment.

Sizes of labels that are referenced are exemplary. Actual sizes may vary from manufacturer to manufacturer and may be affected by mounting areas or design constraints.

NOTE: Use labels provided by your OEM (original equipment manufacturer).

1. Ensure that the surface to which labels will be applied is free of dirt, dust, grease and moisture.
2. Place all new labels in the same positions as the labels being replaced. Refer to OEM manuals for proper location.
3. If the surface is freshly painted, ensure that the paint is dry.
4. Press the label firmly after applying it to the surface. One or more passes over the label with a sponge or rubber roller will ensure that the adhesive is in good contact with the surface.



LOADING DOCK EQUIPMENT MANUFACTURERS

Loading Dock Equipment Manufacturers Safety Labels

The following labels were developed for LODEM to conform to ANSI Z535. Labels may contain safety alert symbols and signal words. To aid in understanding such symbols and signal words, the following has been excerpted from ANSI Z535.4:

Safety Alert Symbols

A symbol which indicates a potential personal injury hazard. It is composed of an equilateral triangle surrounding an exclamation mark. The safety alert symbol shall not be used to alert persons to property-damage-only accidents.



for use with DANGER signal word



for use with WARNING signal word



for use with CAUTION signal word

Signal Words

The meaning of different signal words as defined by ANSI Z535.6 and Z535.4 standards may be provided in collateral materials. The following artwork may be used for this purpose.

DANGER

Indicates an imminently hazardous situation which, if not avoided, will result in death or serious injury.

CAUTION

Indicates a potentially hazardous situation which, if not avoided may result in minor or moderate injury.

WARNING

Indicates a potentially hazardous situation which, if not avoided, could result in death or serious injury.

NOTICE

Notice is used to address practices not related to personal injury.

Note:

DANGER, WARNING or CAUTION should not be considered for property damage accidents unless personal injury risk appropriate to these levels is involved. NOTICE is the preferred signal word to address practices not related to personal injury. It is the intention of the ANSI Z535 committee to eliminate the alternative of using the signal word "CAUTION" without the safety alert symbol to indicate a hazardous situation not related to personal injury in 2011 version of the standard.

SAFETY LABEL PLACEMENT GUIDELINES

For horizontal storing dock levelers

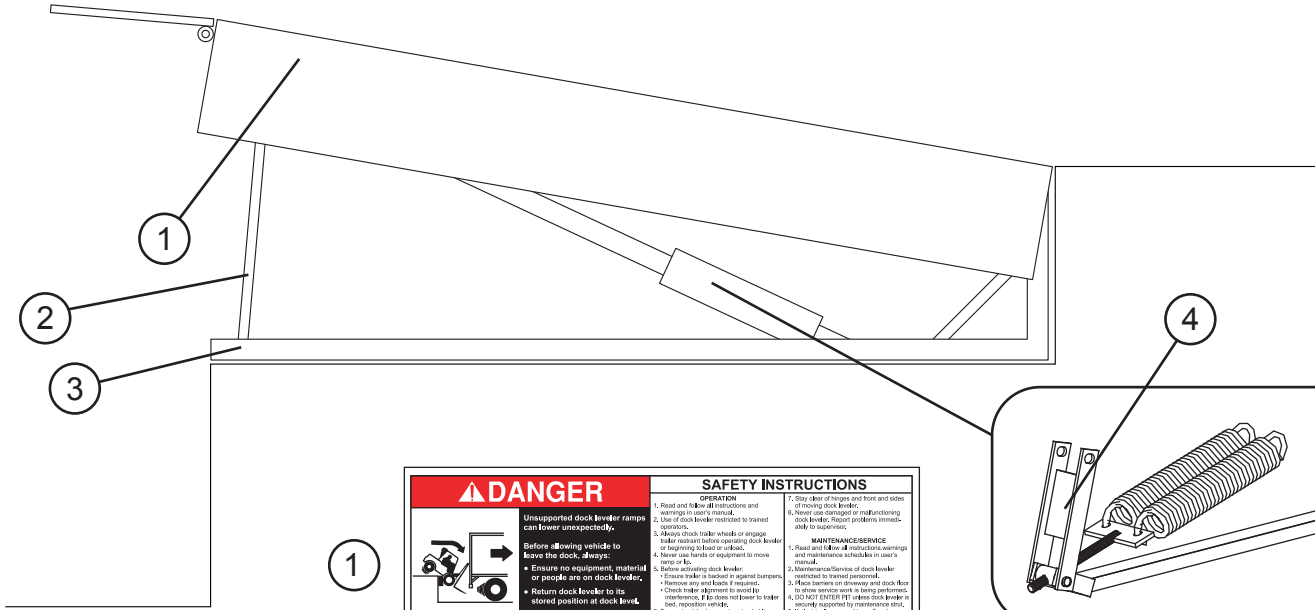

1

⚠ DANGER	<p>Unsupported dock leveler ramps can lower unexpectedly.</p> <p>Before allowing vehicle to leave the dock, always:</p> <ul style="list-style-type: none"> • Ensure no equipment, material or people are on dock leveler. • Return dock leveler to its stored position at dock level. <p><small>Failure to follow posted instructions will result in death or serious injury.</small></p>	<p style="text-align: center;">SAFETY INSTRUCTIONS</p> <p>OPERATION</p> <ol style="list-style-type: none"> 1. Read and follow all instructions and warnings in user's manual. 2. Use of dock leveler restricted to trained operators. 3. Always check trailer wheels or engage trailer support before operating dock leveler. 4. Never use hand or equipment to move ramp or lift. 5. Ensure trailer is supported in upright position. 6. Remove any and blocks if required. 7. Check trailer alignment to avoid tire interference. If it does not power to trailer lock, reposition vehicle. 8. Ensure truck bed supports extended by or breaker frame supports ramp before driving forward. <p><small>Call for replacement placards, warning labels, or user's manual.</small></p>
-----------------	---	--

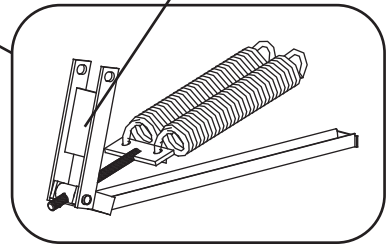

(Mechanical models only)

2

⚠ DANGER	<p>CRUSH HAZARD</p> <p>Do not work under dock leveler unless this maintenance strut has been secured in the upright position. See user's manual for proper procedures.</p>
-----------------	---

3

⚠ DANGER	<p>CRUSH HAZARD</p> <p>DO NOT ENTER PIT unless dock leveler is securely supported by the maintenance strut. Place barriers on driveway and dock floor to indicate service work being performed. Failure to comply will result in death or serious injury. Refer to user's manual for proper maintenance procedures.</p>
-----------------	---

4

⚠ DANGER	<p>CRUSH HAZARD</p> <p>Do not remove main springs until leveler is securely supported by a suitable lifting device. Main springs contain stored energy. Be sure springs are fully unloaded and ends are loose before removal. Failure to comply will result in death or serious injury. Refer to User's Manual for proper maintenance procedure.</p>
-----------------	---

(Mechanical models only)

5

⚠ DANGER	OPERATING INSTRUCTIONS

See page 13.

SAFETY LABEL PLACEMENT GUIDELINES

1.

Size: 9-1/8" wide x 3-1/4" tall

Purpose

This label is specified as part of the labeling recommendation. It should be applied to each side fixed working range toe guard. It is intended to warn operating personnel using the dock leveler and service personnel maintaining the dock leveler of possible bodily hazards.

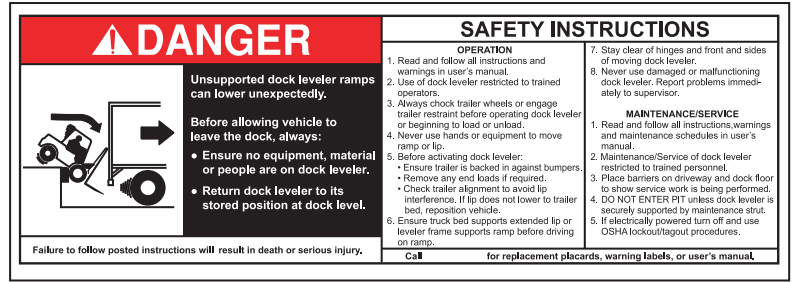

2.

Size: 8" wide x 15/16" tall

Purpose

This label is part of the labeling recommendation. It should be applied to the maintenance support. It is intended to warn operating personnel using the dock leveler and service personnel maintaining the dock leveler to securely support the dock leveler with the maintenance support before work is done under the dock leveler.



3.

Size: 5-7/8" wide x 2-7/16" tall

Purpose

This label is part of the labeling recommendation. It should be applied to the dock leveler sub-frame near the driveway end. It is intended to warn operating personnel using the dock leveler and service personnel maintaining the leveler to securely support the dock leveler with the maintenance support and to place barriers on the drive surface and dock floor before working on or under the dock leveler.

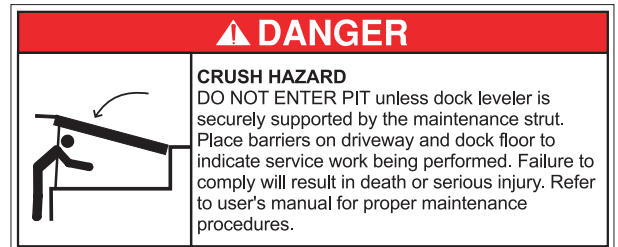

4.

Size: 2-1/2" wide x 4" tall

Purpose

This additional label is part of the labeling recommendation for mechanical dock levelers only. It should be applied on or near the counterbalance mechanism visible from the driveway. It is intended to warn operating personnel using the dock leveler and service personnel maintaining the leveler to securely support the dock leveler before working on or under the dock leveler, before working on the counterbalance system and about the possible hazard of energy being stored in the main springs.

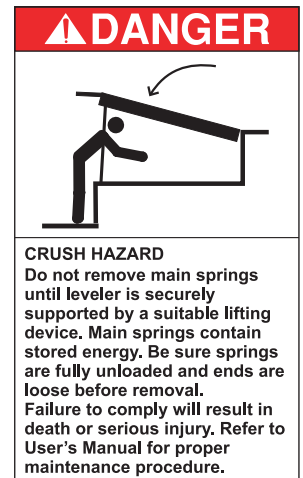

SAFETY LABEL PLACEMENT GUIDELINES

For EOD levelers



1

	<p>▲ DANGER</p> <p>Unsupported dock leveler ramps can lower unexpectedly.</p> <p>Before allowing vehicle to leave the dock, always:</p> <ul style="list-style-type: none"> • Ensure no equipment, material or people are on dock leveler. • Return dock leveler to its stored position at dock level. <p>Failure to follow posted instructions will result in death or serious injury.</p>	<p>SAFETY INSTRUCTIONS</p> <p>OPERATION</p> <ol style="list-style-type: none"> 1. Read and follow all instructions and warnings in user's manual. 2. Use of dock leveler restricted to trained operators. 3. Always check trailer wheels or engage trailer restraint before operating dock leveler to prevent it from collapsing. 4. Never use hands or equipment to move trailer into or out of dock leveler. 5. Ensure trailer is locked in against bumpers, restraints, etc. to allow safe travel to trailer dock reception vehicle. 6. Ensure truck and supports extended fully or break fully supports ramp before driving on ramp. <p>MAINTENANCE/SERVICE</p> <ol style="list-style-type: none"> 1. Shut and lock all motion coverings and maintenance struts in user's manual. 2. Maintenance/service of dock leveler restricted to trained personnel. 3. Check tension on drive wire and dock floor to show service work is being performed. 4. DO NOT ENTER PE unless dock leveler is double supported by maintenance strut. 5. If double support is not used, OSHA lockout/tagout procedures.
	<p>Call for replacement parts, warning labels, or user's manual.</p>	

6

<p>▲ DANGER</p> <p>Ramp swings toward you. Stand Clear. Use maintenance strut while servicing. Failure to do so will result in death or serious injury.</p> <p>Refer to user's manual for proper procedure.</p>
--

5

<p>▲ DANGER</p>	<p>OPERATING INSTRUCTIONS</p>

See page 13.

SAFETY LABEL PLACEMENT GUIDELINES

1.

Size: 9-1/8" wide x 3-1/4" tall

Purpose

This label is part of the labeling recommendation for EOD levelers. It should be applied to one side of each bumper block. It is intended to warn operating personnel using the dock leveler and service personnel maintaining the dock leveler of possible bodily hazards.

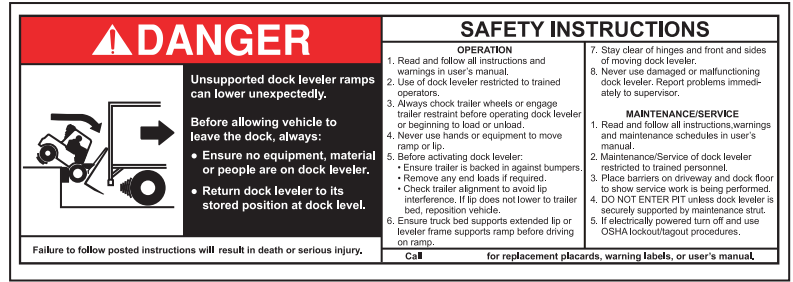

6.

Size: 4-5/16" wide x 7-1/4" tall.

Purpose

This label is part of the labeling recommendation. It should be applied to the EOD leveler underneath the ramp. It is intended to warn personnel in front of or under the dock leveler (including service personnel maintaining the dock leveler) of possible bodily hazards.



SAFETY LABEL PLACEMENT GUIDELINES

For vertical storing dock levelers

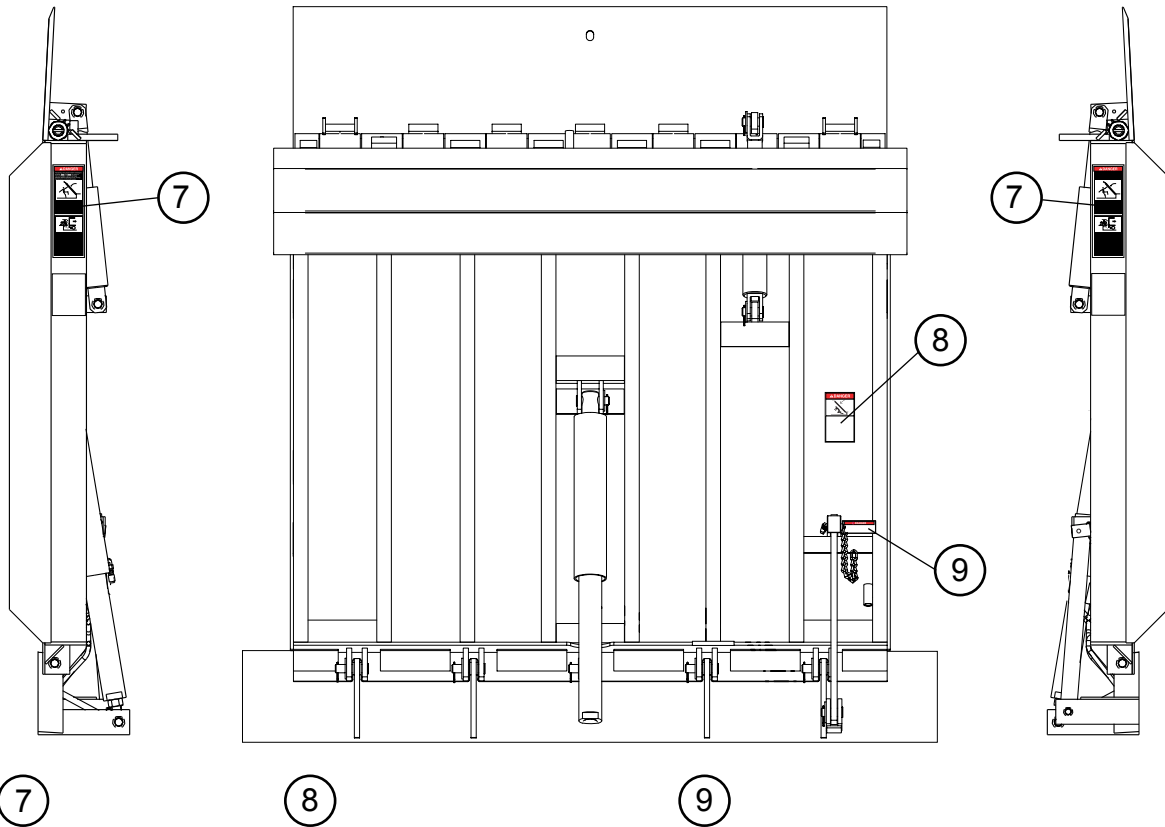

▲ DANGER

CRUSH HAZARD

DO NOT WALK IN FRONT OF DOCK LEVELER until you:

- Restores the dock leveler to its safe stored vertical position with lip extended.

Unsupported dock levelers can lower unexpectedly.

Before allowing vehicle to leave the dock, always:

- Ensure that no equipment, material or people are on dock leveler.
- Restores dock leveler to its safe stored vertical position with lip extended.

SAFETY INSTRUCTIONS

OPERATION

- Read and follow all instructions and warnings in user's manual.
- Use of dock leveler restricted to trained operators.
- Always check trailer wheels or engage trailer restraint before operating dock leveler or beginning to load or unload.
- Never use hands or equipment to move ramp or lip.
- Before activating dock leveler:
 - Ensure trailer is backed in against bumpers.
 - Remove any and loads if required.
 - Check trailer alignment to avoid lip interference. If lip does not lower to trailer bed, reposition vehicle.
- Ensure truck bed supports extended lip or leveler frame supports ramp before driving on ramp.
- Stay clear of hinges and front and sides of moving dock leveler.
- Never use damaged or malfunctioning dock leveler. Report problems immediately to supervisor.

MAINTENANCE SERVICE

- Read and follow all instructions, warnings and maintenance schedules in user's manual.
- Maintenance service of dock leveler restricted to trained personnel.
- Place barriers on the driveway and dock floor to show service work is being performed.
- DO NOT SERVICE LEVELER** unless dock leveler is securely supported by maintenance lock-out pin.
- Turn off power and use OSHA lockout/tagout procedures.

Failure to follow posted instructions will result in death or serious injury.

▲ DANGER

CRUSH HAZARD

Before doing any maintenance, repair, or adjustments on the dock leveler, store the leveler in a vertical position with lip extended, and engage the lock-out pin in the maintenance strut.

Do not remove the lock-out pin from the maintenance strut until you are sure the hydraulic system is in proper working condition. Do not stand in front of the dock leveler while removing the lock-out pin. Reach from the side of the leveler.

Do not force the lock-out pin out of the maintenance strut. If the pin does not slide freely, support the leveler securely using other means and determine the cause of the interference.

Failure to follow these instructions will result in death or serious injury.

Refer to user's manual for proper procedure

▲ DANGER

Do not remove the lock-out pin from the maintenance post unless authorized personnel have confirmed that the hydraulic cylinders, valve and hoses have been properly installed and filled with fluid. Failure to do so will result in death or serious injury.

Refer to user's manual for proper procedure

5

▲ DANGER		OPERATING INSTRUCTIONS

See page 13.

SAFETY LABEL PLACEMENT GUIDELINES

7.

Size: 3-3/4" x 14"

Purpose

This label is part of the labeling recommendation for vertically storing dock levelers. It should be applied to each side of the dock leveler. It is intended to warn operating personnel using the dock leveler and service personnel maintaining the dock leveler of possible bodily hazards.

⚠ DANGER

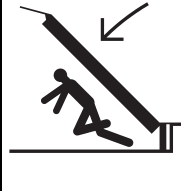

CRUSH HAZARD

DO NOT WALK IN FRONT OF DOCK LEVELER until you:

- Restore the dock leveler to its safe stored vertical position with lip extended.



Unsupported dock levelers can lower unexpectedly.

Before allowing vehicle to leave the dock, always:

- Ensure that no equipment, material or people are on dock leveler.

• Restore dock leveler to its safe stored vertical position with lip extended.

SAFETY INSTRUCTIONS

OPERATION

1. Read and follow all instructions and warnings in user's manual.
2. Use of dock leveler restricted to trained operators.
3. Always chock trailer wheels or engage trailer restraint before operating dock leveler or beginning to load or unload.
4. Never use hands or equipment to move ramp or lip.
5. Before activating dock leveler:
 - Ensure trailer is backed in against bumpers.
 - Remove any end loads if required.
 - Check trailer alignment to avoid lip interference. If lip does not lower to trailer bed, reposition vehicle.
6. Ensure truck bed supports extended lip or leveler frame supports ramp before driving on ramp.
7. Stay clear of hinges and front and sides of moving dock leveler.
8. Never use damaged or malfunctioning dock leveler. Report problems immediately to supervisor.

MAINTENANCE/SERVICE

1. Read and follow all instructions, warnings and maintenance schedules in user's manual.
2. Maintenance/Service of dock leveler restricted to trained personnel.
3. Place barriers on the driveway and dock floor to show service work is being performed.
4. **DO NOT SERVICE LEVELER** unless dock leveler is securely supported by maintenance lock-out pin.
5. Turn off power and use OSHA lockout/tagout procedures.

Failure to follow posted instructions will result in death or serious injury.

June 2009

Safety Label Brochure for Dock Levelers

11

SAFETY LABEL PLACEMENT GUIDELINES

For vertical storing dock levelers (continued)

8.

Size: 4" x 6-3/4"

Purpose

This label is part of the labeling recommendation for vertical storing dock levelers. It should be applied to the under surface of the leveler deck near the maintenance lock-out pin. It is intended to warn service personnel maintaining the dock leveler of bodily hazards associated with maintenance, repair or adjustment of the dock leveler without the maintenance lock-out pin securely in position.

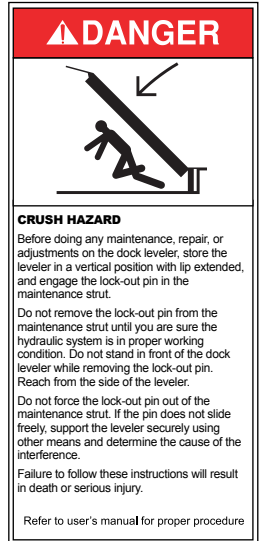

9.

Size: 1-1/2" x 4"

Purpose

This label is part of the labeling recommendation for vertical storing dock levelers. It should be applied to the maintenance lock-out pin or to a chain or cable that tethers the pin to the dock leveler. It is intended to warn operating and service personnel of bodily hazards associated with removal of the maintenance lock-out pin without hydraulic support that is properly filled, connected and functioning.

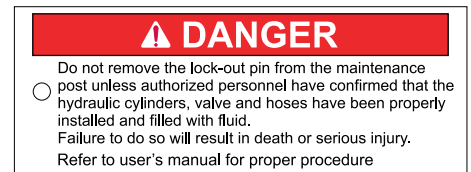











SAFETY LABEL PLACEMENT GUIDELINES

5.

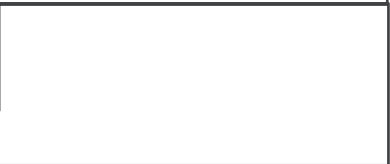
Size: 8-1/2" x 11"

Purpose

This placard should be located in plain sight on a wall surface adjacent to each leveler location. It is intended to warn personnel of potential hazards and to provide operating instructions for the leveler.

▲ DANGER	OPERATING INSTRUCTIONS
	 
	 
	 
	 
<hr data-bbox="191 1499 769 1503"/>	 

SAFETY LABEL PLACEMENT GUIDELINES

For all powered levelers

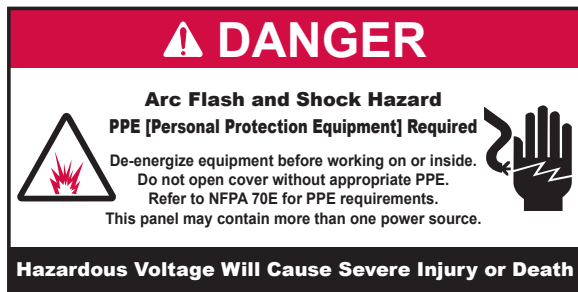

Label: 10 (3" wide x 1-1/2" tall)
or
Label: 11 (6" wide x 3" tall)

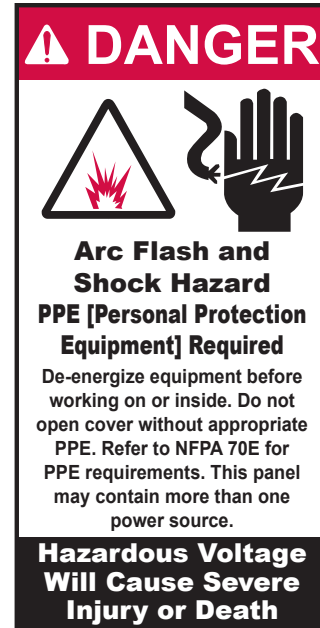

Label: 12 (1-1/2" wide x 3" tall)
or
Label: 13 (3" wide x 6" tall)

Purpose

This label is recommended for all powered dock levelers where space permits. It should be applied on the outside surface of all electrical enclosures which contain contact devices (i.e., motor starters, controllers, disconnects, relays, etc.). The size and shape of the panel should dictate which of the labels is appropriate. It is intended to warn personnel of both electrical and arc flash hazards.



LOADING DOCK EQUIPMENT MANUFACTURERS

**Loading Dock Equipment Manufacturers Product Section of
The Material Handling Industry of America**

8720 Red Oak Boulevard, Suite 201

Charlotte, NC 28217-3992

Telephone: (704) 676-1190

FAX: (704) 676-1199

www.mhia.org



LOADING DOCK EQUIPMENT MANUFACTURERS